

The background of the advertisement is a photograph of a modern living room. On the left, a white brick wall features a tall, white, vertical radiator. In the center, a brown leather armchair with a striped pillow sits on a light-colored rug. To the right, a large window with a dark frame offers a view of a lush green forest. A small wooden table with a chess piece is visible near the window. The overall atmosphere is bright and airy.

zehnder

Zehnder radiatori e scaldasalviette

Soluzioni per rendere unico ogni ambiente

www.zehnder.it

always the best climate

2 colonne

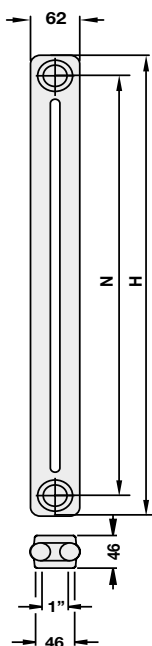

CHARLESTON - RADIATORI TUBOLARI IN ACCIAIO BIANCO RAL 9016

2 COLONNE - PROFONDITÀ: 62 MM

CODICE	INTERASSE mm	MODELLO	ALTEZZA mm	RESA TERMICA		CODICE FORNITORE	PREZZO €
				Δ T 50° W	Δ T 30° W		
	202	2026	260	21,1	11	2026-001-S001-9016	23,43
	234	2030	292	23,6	12,3	2030-001-S001-9016	24,77
	284	2035	342	27,5	14,4	2035-001-S001-9016	24,88
	334	2040	392	31,2	16,4	2040-001-S001-9016	24,88
	384	2045	442	34,9	18,3	2045-001-S001-9016	25,08
	434	2050	492	38,4	20,3	2050-001-S001-9016	25,08
	484	2055	542	41,9	22,1	2055-001-S001-9016	25,50
	500	2056	558	43	22,7	2056-001-S001-9016	25,50
	530	2059	588	45	23,8	2059-001-S001-9016	25,60
	534	2060	592	45,3	23,9	2060-001-S001-9016	25,71
	570	2063	628	47,7	25,3	2063-001-S001-9016	26,22
	600	2066	658	49,7	26,4	2066-001-S001-9016	26,33
	619	2068	677	50,9	27	2068-001-S001-9016	26,64
	684	2075	742	55	29,2	2075-001-S001-9016	28,09
	700	2076	758	56	29,7	2076-001-S001-9016	28,61
	730	2079	788	57,8	30,8	2079-001-S001-9016	29,02
	800	2086	858	62	33,1	2086-001-S001-9016	29,64
	819	2088	877	63,1	33,7	2088-001-S001-9016	30,89
	834	2090	892	63,9	34,1	2090-001-S001-9016	31,72
	870	2093	928	66	35,4	2093-001-S001-9016	32,34
	900	2096	958	67,6	36,2	2096-001-S001-9016	33,17
	934	2100	992	69,5	37,3	2100-001-S001-9016	33,27
	1034	2110	1092	74,7	40,3	2110-001-S001-9016	34,31
	1134	2120	1192	82,7	42,6	2120-001-S001-9016	38,66
	1434	2150	1492	104	53,8	2150-001-S001-9016	51,30
	1600	2166	1658	115	59,5	2166-001-S001-9016	55,40
	1734	2180	1792	124	64,2	2180-001-S001-9016	59,50
	1800	2186	1858	129	66,7	2186-001-S001-9016	63,50
	1934	2200	1992	138	71,8	2200-001-S001-9016	63,80
	2000	2206	2058	142	73,8	2206-001-S001-9016	67,70
	2134	2220	2192	151	78,5	2220-001-S001-9016	77,40
	2434	2250	2492	171	88,9	2250-001-S001-9016	86,50
	2734	2280	2792	189	98,8	2280-001-S001-9016	104,60
	2934	2300	2992	201	105,1	2300-001-S001-9016	111,30

Potenze termiche in base alla normativa EN 442 con tM=75°C, tR=65°C, tA=20°C

Prezzo con verniciatura standard - RAL 9016 - (su richiesta, con supplemento, vedere colorazioni cartella colori Zehnder)

Per ordinare le batterie di radiatori bisogna sostituire a **001** il numero degli elementi desiderati (minimo 3 elementi), e sostituire a S001 il codice dell'attacco richiesto.

(Esempio per ordinare un Charleston modello 2026 con attacco S001 in batteria da 5 elementi il codice è: 2026-**005**-S001-9016).

I prezzi sopra riportati sono riferiti ad un singolo elemento con attacchi senza supplemento

3 colonne
3 colonne
EasyAccess

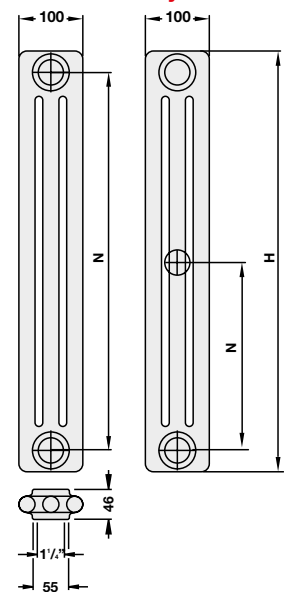

EASY ACCESS

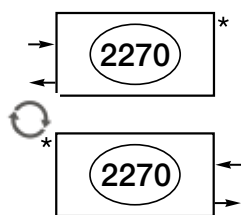

CHARLESTON - RADIATORI TUBOLARI IN ACCIAIO BIANCO RAL 9016

3 COLONNE - PROFONDITÀ: 100 MM

CODICE	INTERASSE mm	MODELLO	ALTEZZA mm	RESA TERMICA		CODICE FORNITORE	PREZZO €
				Δ T 50° W	Δ T 30° W		
	194	3026	260	27,9	14,5	3026-001-S001-9016	25,50
	234	3030	300	32	16,6	3030-001-S001-9016	25,50
	284	3035	350	37	19,2	3035-001-S001-9016	25,60
	334	3040	400	41,9	21,8	3040-001-S001-9016	25,71
	384	3045	450	46,8	24,5	3045-001-S001-9016	26,12
	434	3050	500	51,6	27	3050-001-S001-9016	26,33
	484	3055	550	56,3	29,4	3055-001-S001-9016	26,53
	500	3057	566	57,8	30,2	3057-001-S001-9016	26,85
	530	3059	596	60,5	31,6	3059-001-S001-9016	26,85
	534	3060	600	60,9	31,8	3060-001-S001-9016	26,85
	570	3064	636	64,2	33,6	3064-001-S001-9016	26,85
	600	3067	666	66,9	35,1	3067-001-S001-9016	27,05
	619	3069	685	68,6	36	3069-001-S001-9016	27,16
	684	3075	750	74,3	39	3075-001-S001-9016	29,64
	700	3077	766	75,7	39,8	3077-001-S001-9016	30,06
	730	3079	796	77,4	40,7	3079-001-S001-9016	30,78
	800	3087	866	84,2	44,2	3087-001-S001-9016	30,99
	819	3089	885	85,8	45,1	3089-001-S001-9016	31,41
	834	3090	900	87	45,9	3090-001-S001-9016	33,69
	870	3094	936	90	47,5	3094-001-S001-9016	38,76
	900	3097	966	92,4	48,8	3097-001-S001-9016	38,87
	934	3100	1000	95,1	50,2	3100-001-S001-9016	39,18
	1034	3110	1100	103	54,4	3110-001-S001-9016	41,87
	1134	3120	1200	115	58,9	3120-001-S001-9016	48,30
	1434	3150	1500	140	71,7	3150-001-S001-9016	65,10
	1600	3167	1666	154	78,9	3167-001-S001-9016	72,90
	1734	3180	1800	166	84,6	3180-001-S001-9016	77,40
	1800	3187	1866	171	87,1	3187-001-S001-9016	82,30
	1934	3200	2000	183	93,2	3200-001-S001-9016	86,10
	2000	3207	2066	188	95,8	3207-001-S001-9016	91,40
	2134	3220	2200	200	101,9	3220-001-S001-9016	101,30
	2434	3250	2500	225	114,6	3250-001-S001-9016	110,30
	2734	3280	2800	251	127,2	3280-001-S001-9016	136,50
	2934	3300	3000	269	136,4	3300-001-S001-9016	146,60
	*EasyAccess	3120	1200	115	58,9	3120-001-2270-9016	48,30
	*EasyAccess	3150	1500	140	71,7	3150-001-2270-9016	65,10
	*EasyAccess	3180	1800	166	84,6	3180-001-2270-9016	77,40
	*EasyAccess	3200	2000	183	93,2	3200-001-2270-9016	86,10
	*EasyAccess	3220	2200	200	101,9	3220-001-2270-9016	101,30

Potenze termiche in base alla normativa EN 442 con tM=75°C, tR=65°C, tA=20°C

Prezzo con verniciatura standard - RAL 9016 - (su richiesta, con supplemento, vedere colorazioni cartella colori Zehnder)

Per ordinare le batterie di radiatori bisogna sostituire a 001 il numero degli elementi desiderati (minimo 3 elementi), e sostituire a S001 il codice dell'attacco richiesto.

(Esempio per ordinare un Charleston modello 3026 con attacco S001 in batteria da 5 elementi il codice è: 3026-005-S001-9016).

I prezzi sopra riportati sono riferiti ad un singolo elemento con attacchi senza supplemento

EASY ACCESS: versione con altezza 1200-1500-1800-2000-2200 mm con allacciamento sostitutivo ghisa e alluminio;

*In fase d'ordine indicare la misura dell'interasse: 450-500-550-600-619-700-800-819-850-900 mm

(Codice allacciamento 2270 con supplemento per ogni radiatore)

4 colonne

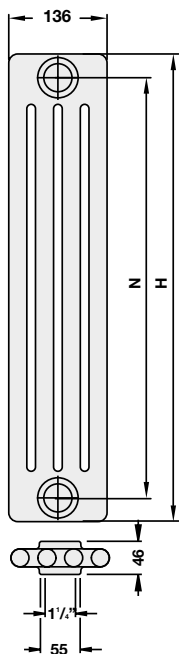

CHARLESTON - RADIATORI TUBOLARI IN ACCIAIO BIANCO RAL 9016

4 COLONNE - PROFONDITÀ: 136 MM

CODICE	INTERASSE mm	MODELLO	ALTEZZA mm	RESA TERMICA		CODICE FORNITORE	PREZZO €
				Δ T 50° W	Δ T 30° W		
	194	4026	260	36,5	19	4026-001-S001-9016	29,33
	234	4030	300	41,9	21,8	4030-001-S001-9016	30,06
	284	4035	350	48,5	25,2	4035-001-S001-9016	30,06
	334	4040	400	54,9	28,5	4040-001-S001-9016	30,47
	384	4045	450	61,3	32	4045-001-S001-9016	30,47
	434	4050	500	67,6	35,3	4050-001-S001-9016	30,58
	484	4055	550	73,7	38,5	4055-001-S001-9016	30,58
	500	4057	566	75,7	39,6	4057-001-S001-9016	30,58
	530	4059	596	79,3	41,5	4059-001-S001-9016	30,89
	534	4060	600	79,8	41,7	4060-001-S001-9016	31,92
	570	4064	636	84,1	44	4064-001-S001-9016	32,23
	600	4067	666	87,6	46	4067-001-S001-9016	32,34
	619	4069	685	89,9	47,2	4069-001-S001-9016	32,44
	684	4075	750	97,4	51,2	4075-001-S001-9016	36,38
	700	4077	766	99,2	52,1	4077-001-S001-9016	36,48
	730	4079	796	103	54,1	4079-001-S001-9016	36,59
	800	4087	866	111	58,3	4087-001-S001-9016	37,52
	819	4089	885	112	58,8	4089-001-S001-9016	38,87
	834	4090	900	114	60,2	4090-001-S001-9016	38,87
	870	4094	936	118	62,3	4094-001-S001-9016	46,23
	900	4097	966	121	63,9	4097-001-S001-9016	47,05
	934	4100	1000	125	66	4100-001-S001-9016	47,16
	1034	4110	1100	135	71,3	4110-001-S001-9016	50,90
	1134	4120	1200	147	75,3	4120-001-S001-9016	59,40
	1434	4150	1500	180	92,2	4150-001-S001-9016	80,20
	1600	4167	1666	198	101,4	4167-001-S001-9016	90,50
	1734	4180	1800	213	108,5	4180-001-S001-9016	96,20
	1800	4187	1866	220	112,1	4187-001-S001-9016	101,10
	1934	4200	2000	234	119,2	4200-001-S001-9016	105,10
	2000	4207	2066	242	123,3	4207-001-S001-9016	110,40
	2134	4220	2200	256	130,4	4220-001-S001-9016	123,00
	2434	4250	2500	289	147,3	4250-001-S001-9016	133,90
	2734	4280	2800	323	163,7	4280-001-S001-9016	166,90
	2934	4300	3000	345	174,9	4300-001-S001-9016	174,30

Potenze termiche in base alla normativa EN 442 con tM=75°C, tR=65°C, tA=20°C

Prezzo con verniciatura standard - RAL 9016 - (su richiesta, con supplemento, vedere colorazioni cartella colori Zehnder)

Per ordinare le batterie di radiatori bisogna sostituire a **001** il numero degli elementi desiderati (minimo 3 elementi), e sostituire a S001 il codice dell'attacco richiesto.

(Esempio per ordinare un Charleston modello 4026 con attacco S001 in batteria da 5 elementi il codice è: 4026-**005**-S001-9016).

I prezzi sopra riportati sono riferiti ad un singolo elemento con attacchi senza supplemento

CHARLESTON - RADIATORI TUBOLARI IN ACCIAIO BIANCO RAL 9016

5 COLONNE - PROFONDITÀ: 173 MM

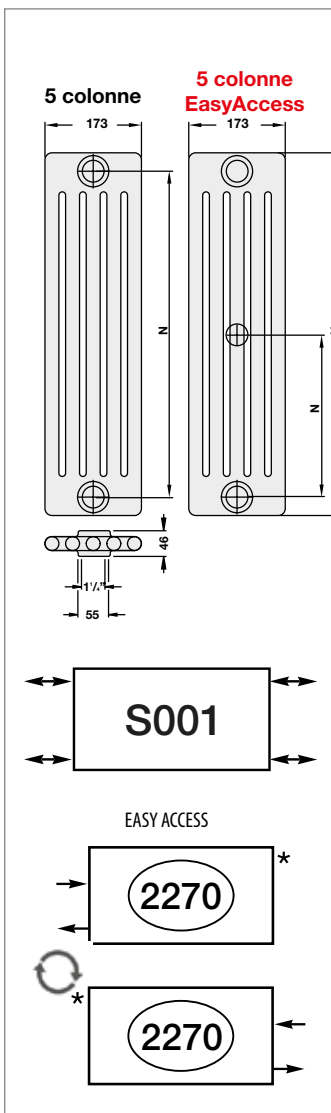

CODICE	INTERASSE mm	MODELLO	ALTEZZA mm	RESA TERMICA		CODICE FORNITORE	PREZZO €
				Δ T 50° W	Δ T 30° W		
	194	5026	260	45,1	23,5	5026-001-S001-9016	41,98
	234	5030	300	51,7	26,9	5030-001-S001-9016	45,40
	284	5035	350	59,9	31,2	5035-001-S001-9016	45,40
	334	5040	400	67,9	35,3	5040-001-S001-9016	45,50
	384	5045	450	75,8	39,6	5045-001-S001-9016	45,71
	434	5050	500	83,5	43,6	5050-001-S001-9016	46,12
	484	5055	550	91,1	47,6	5055-001-S001-9016	47,26
	500	5057	566	93,5	48,9	5057-001-S001-9016	49,44
	534	5060	600	98,6	51,5	5060-001-S001-9016	50,50
	600	5067	666	108	56,7	5067-001-S001-9016	52,40
	619	5069	685	111	58,3	5069-001-S001-9016	54,50
	684	5075	750	120	63	5075-001-S001-9016	55,60
	700	5077	766	123	64,6	5077-001-S001-9016	56,10
	800	5087	866	136	71,5	5087-001-S001-9016	59,50
	819	5089	885	139	73	5089-001-S001-9016	60,80
	834	5090	900	141	74,5	5090-001-S001-9016	62,10
	900	5097	966	149,6	79	5097-001-S001-9016	63,80
	934	5100	1000	154	81,3	5100-001-S001-9016	65,30
	1034	5110	1100	167	88,2	5110-001-S001-9016	67,60
	1134	5120	1200	179	91,7	5120-001-S001-9016	75,90
	1434	5150	1500	219	112,2	5150-001-S001-9016	101,70
	1734	5180	1800	259	132	5180-001-S001-9016	122,80
	1934	5200	2000	285	145,2	5200-001-S001-9016	136,20
	2134	5220	2200	312	159	5220-001-S001-9016	151,20
	2434	5250	2500	352	179,4	5250-001-S001-9016	165,70
	2734	5280	2800	392	198,7	5280-001-S001-9016	205,00
	2934	5300	3000	420	212,9	5300-001-S001-9016	220,00
*EasyAccess	5120	5120	1200	179	91,7	5120-001-2270-9016	75,90
*EasyAccess	5150	5150	1500	219	112,2	5150-001-2270-9016	101,70
*EasyAccess	5180	5180	1800	259	132	5180-001-2270-9016	122,80
*EasyAccess	5200	5200	2000	285	145,2	5200-001-2270-9016	136,20
*EasyAccess	5220	5220	2200	312	159	5220-001-2270-9016	151,20

Potenze termiche in base alla normativa EN 442 con tM=75°C, tR=65°C, tA=20°C
 Prezzo con verniciatura standard - RAL 9016 - (su richiesta, con supplemento, vedere colorazioni cartella colori Zehnder)
 Per ordinare le batterie di radiatori bisogna sostituire a **001** il numero degli elementi desiderati (minimo 3 elementi), e sostituire a S001 il codice dell'attacco richiesto.
 (Esempio per ordinare un Charleston modello 5026 con attacco S001 in batteria da 5 elementi il codice è 5026-**005**-S001-9016).
 I prezzi sopra riportati sono riferiti ad un singolo elemento con attacchi senza supplemento.
EASY ACCESS: versione con altezza 1200-1500-1800-2000-2200 mm con allacciamento sostitutivo ghisa e alluminio;
 * In fase d'ordine indicare la misura dell'interasse: 450-500-550-600-619-700-800-819-850-900 mm
 (Codice allacciamento **2270 con supplemento** per ogni radiatore)

CHARLESTON - RADIATORI TUBOLARI IN ACCIAIO BIANCO RAL 9016

6 COLONNE - PROFONDITÀ: 210 MM

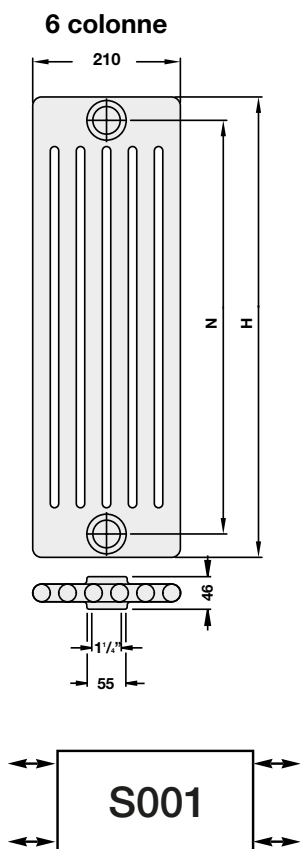

CODICE	INTERASSE mm	MODELLO	ALTEZZA mm	RESA TERMICA		CODICE FORNITORE	PREZZO €
				$\Delta T 50^\circ$ W	$\Delta T 30^\circ$ W		
	194	6026	260	53,5	27,8	6026-001-S001-9016	48,92
	234	6030	300	61,3	31,9	6030-001-S001-9016	54,70
	284	6035	350	71	36,9	6035-001-S001-9016	54,70
	334	6040	400	80,5	41,9	6040-001-S001-9016	54,90
	384	6045	450	89,8	46,9	6045-001-S001-9016	55,10
	434	6050	500	99	51,7	6050-001-S001-9016	55,20
	484	6055	550	108	56,5	6055-001-S001-9016	55,20
	500	6057	566	111	58	6057-001-S001-9016	58,10
	534	6060	600	117	61,2	6060-001-S001-9016	58,60
	600	6067	666	128	67,2	6067-001-S001-9016	63,40
	684	6075	750	143	75,1	6075-001-S001-9016	66,50
	700	6077	766	147	77,2	6077-001-S001-9016	69,20
	800	6087	866	162	85,1	6087-001-S001-9016	76,60
	819	6089	885	165	86,7	6089-001-S001-9016	78,00
	834	6090	900	167	88,2	6090-001-S001-9016	79,80
	900	6097	966	177	93,5	6097-001-S001-9016	80,70
	934	6100	1000	183	96,6	6100-001-S001-9016	80,90
	1034	6110	1100	198	104,6	6110-001-S001-9016	81,80
	1134	6120	1200	210	107,5	6120-001-S001-9016	95,60
	1434	6150	1500	256	131,1	6150-001-S001-9016	125,20
	1734	6180	1800	303	154,4	6180-001-S001-9016	150,10
	1934	6200	2000	334	170,2	6200-001-S001-9016	166,10
	2134	6220	2200	365	186	6220-001-S001-9016	180,80
	2434	6250	2500	412	209,9	6250-001-S001-9016	202,00
	2734	6280	2800	459	232,7	6280-001-S001-9016	249,00
	2934	6300	3000	491	248,9	6300-001-S001-9016	265,00

Potenze termiche in base alla normativa EN 442 con $t_M=75^\circ\text{C}$, $t_R=65^\circ\text{C}$, $t_A=20^\circ\text{C}$

Prezzo con verniciatura standard - RAL 9016 - (su richiesta, con supplemento, vedere colorazioni cartella colori Zehnder)

Per ordinare le batterie di radiatori bisogna sostituire a **001** il numero degli elementi desiderati (minimo 3 elementi), e sostituire a S001 il codice dell'attacco richiesto.

(Esempio per ordinare un Charleston modello 6026 con attacco S001 in batteria da 5 elementi il codice è: 6026-**005**-S001-9016).

I prezzi sopra riportati sono riferiti ad un singolo elemento con attacchi senza supplemento

Allacciamenti Zehnder Charleston

ALLACCIAMENTI STANDARD SENZA SUPPLEMENTO

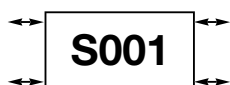

S001



1 valvola di sfiato da 1/2" e 1 tappo nichelato da 1/2" compresi nella fornitura

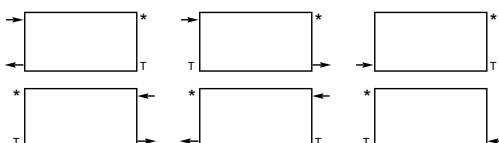

Allacciamento monotubo: la dotazione deve essere completa con un tappo supplementare da 1/2"

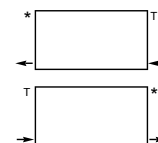

Allacciamento laterale basso: riduzione della potenza termica del radiatore da 2-6% in base alle dimensioni

S062

Batteria nipplabile fornita senza tappi e riduzioni. Non possibile per la finitura Technoline

ALLACCIAMENTI SENZA SUPPLEMENTO

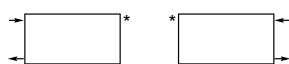

1270

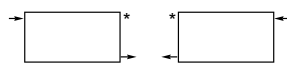

1670

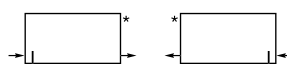

2670

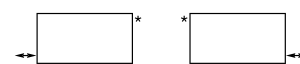

2070

ALLACCIAMENTI CON SUPPLEMENTO

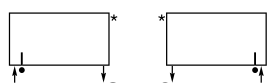

3570

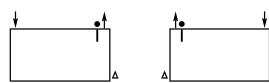

9806

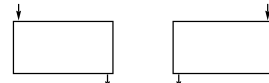

9500

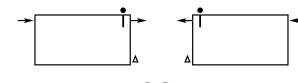

1706

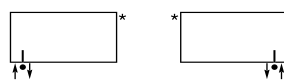

3370

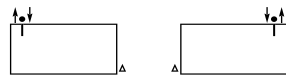

9906

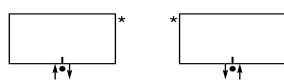

3470

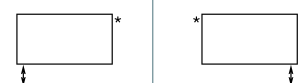

3070



5010

ATTACCO CON VALVOLA INTEGRATA - CON SUPPLEMENTO (prezzi senza termostato)

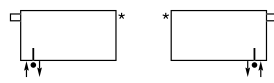

V001

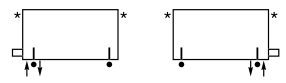

V003

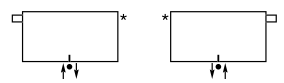

V007

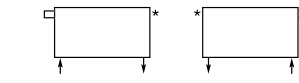

V011

ATTACCO MODELLO EASYACCESS - CON SUPPLEMENTO



LEGENDA

* = sfiato
Δ = scarico

T = Tappo
• = diaframma



SCALDASALVIETTE BIANCO RAL 9016 - AURA								
VERSIONE ACQUA CALDA E MISTA VERNICIATA								
CODICE	MODELLO	INTERASSE mm	ALTEZZA mm	LARGHEZZA mm	PROFONDITÀ mm	POTENZA TERMICA Δ T30 W	CODICE FORNITORE	PREZZO €
0203514	PBN-080-040	350	775	400	30	153	PBN-080-040-3580-9016	211,00
0203515	PBN-080-045	400	775	450	30	177	PBN-080-045-3580-9016	211,00
0203516•	PBN-080-050	450	775	500	30	193	PBN-080-050-3580-9016	211,00
0203517	PBN-080-055	500	775	550	30	211	PBN-080-055-3580-9016	211,00
0203518	PBN-080-060	550	775	600	30	229	PBN-080-060-3580-9016	211,00
0203519•	PBN-120-040	350	1217	400	30	228	PBN-120-040-3580-9016	253,00
0203520•	PBN-120-045	400	1217	450	30	250	PBN-120-045-3580-9016	253,00
0091075•	PBN-120-050	450	1217	500	30	273	PBN-120-050-3580-9016	253,00
0203521•	PBN-120-055	500	1217	550	30	295	PBN-120-055-3580-9016	253,00
0117144	PBN-120-060	550	1217	600	30	317	PBN-120-060-3580-9016	253,00
0203522	PBN-120-075	700	1217	750	30	385	PBN-120-075-3580-9016	300,00
0203523•	PBN-150-040	350	1469	400	30	280	PBN-150-040-3580-9016	310,00
0203524•	PBN-150-045	400	1469	450	30	306	PBN-150-045-3580-9016	310,00
0117145•	PBN-150-050	450	1469	500	30	334	PBN-150-050-3580-9016	310,00
0203525•	PBN-150-055	500	1469	550	30	363	PBN-150-055-3580-9016	310,00
0117146•	PBN-150-060	550	1469	600	30	391	PBN-150-060-3580-9016	310,00
0117147	PBN-150-075	700	1469	750	30	480	PBN-150-075-3580-9016	389,00
0203526•	PBN-180-040	350	1856	400	30	346	PBN-180-040-3580-9016	367,00
0203527•	PBN-180-045	400	1856	450	30	382	PBN-180-045-3580-9016	367,00
0203528•	PBN-180-050	450	1856	500	30	417	PBN-180-050-3580-9016	367,00
0203529•	PBN-180-055	500	1856	550	30	453	PBN-180-055-3580-9016	367,00
0203530•	PBN-180-060	550	1856	600	30	489	PBN-180-060-3580-9016	367,00
0203531•	PBN-180-075	700	1856	750	30	597	PBN-180-075-3580-9016	479,00

Alcune misure sono disponibili anche cromo e nero opaco



VERSIONE ELETTRICA VERNICIATA CON RESISTENZA MUSA								
CODICE	MODELLO	ALTEZZA mm	LARGHEZZA mm	PROFONDITÀ mm	POTENZA TERMICA Δ T30 W	CODICE FORNITORE	PREZZO €	
0007513•	Aura elettrico Musa	860	400	30	300	PBEZ-080-40/MQ-9016	415,00	
0007514•	Aura elettrico Musa	980	500	30	500	PBEZ-090-50/MQ-9016	484,00	
0007512•	Aura elettrico Musa	1300	500	30	750	PBEZ-120-50/MQ-9016	576,00	
0158612	Aura elettrico Musa	1300	600	30	750	PBEZ-120-60/MQ-9016	590,00	
0014381•	Aura elettrico Musa	1540	500	30	750	PBEZ-150-50/MQ-9016	661,00	
0007515•	Aura elettrico Musa	1540	600	30	1000	PBEZ-150-60/MQ-9016	681,00	
0016622•	Aura elettrico Musa	1940	500	30	1000	PBEZ-180-50/MQ-9016	749,00	
0158613	Aura elettrico Musa	1940	600	30	1000	PBEZ-180-60/MQ-9016	765,00	

* Altezza comprensiva della scatola di comando



VERSIONE ELETTRICA VERNICIATA CON RESISTENZA WR								
CODICE	MODELLO	ALTEZZA mm	LARGHEZZA mm	PROFONDITÀ mm	POTENZA TERMICA Δ T30 W	CODICE FORNITORE	PREZZO €	
0212957	Aura elettrico WR	786	400	30	300	PBEZ-080-40/F-9016	288,00	
0212958•	Aura elettrico WR	906	500	30	500	PBEZ-090-50/F-9016	335,00	
0212959	Aura elettrico WR	1226	500	30	750	PBEZ-120-50/F-9016	413,00	
0212960	Aura elettrico WR	1226	600	30	750	PBEZ-120-60/F-9016	437,00	
0212961	Aura elettrico WR	1466	600	30	1000	PBEZ-150-60/F-9016	496,00	
0212962	Aura elettrico WR	1866	500	30	1000	PBEZ-180-50/F-9016	552,00	

* Altezza comprensiva della scatola di comando

Zehnder World of Colours

Warm colours

+25%

Cool colours







CORE

 White Quartz OPACO 0521	 Pure White BRILLANTE 9010 = RAL 9010	 Edelweiss OPACO 0067
 Cream BRILLANTE 9001 = RAL 9001	 Telegrey 4 OPACO 7247 = RAL 7047	 Beige Quartz OPACO 0523
 Golden sand OPACO 0258	 Yellow Grey OPACO 7234 = RAL 7034	 Pearl Beige OPACO 1235 = RAL 1035
 Beach Gold OPACO 0272	 Concrete Grey OPACO 0265	 Beige Grey OPACO 0267
 Bronze OPACO 0276	 Brown Quartz OPACO 0529	 Dark Brown OPACO 0270
 Grey Aluminium BRILLANTE 9007	 Anthracite BRILLANTE 0346	 Umbra Grey OPACO 7222 = RAL 7022
 Volcanic BRILLANTE 0336		

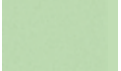
CORE

 White Matt OPACO 0556	 Light Beige OPACO 0253	 Light Grey OPACO 0262
 White Aluminium BRILLANTE 9006	 Light Jeans OPACO 0264	 Titane BRILLANTE 0335
 Inox Look BRILLANTE 0332	 Telegrey 2 OPACO 7246 = RAL 7046	 Blue Grey OPACO 7231 = RAL 7031
 Anthracite Grey BRILLANTE 7016 = RAL 7016	 Black Quartz OPACO 0550	 Black Matt OPACO 0557
 Traffic Black OPACO 9217 = RAL 9017	 Jet Black BRILLANTE 9005 = RAL 9005	

TREND

 Pastel Green OPACO 6219 = RAL 6019	 Reseda Green OPACO 6211 = RAL 6011	 Cement Grey OPACO 7233 = RAL 7033
 Olive Green OPACO 6203 = RAL 6003	 Terracotta Faded OPACO 0299	 Terracotta OPACO 0292
 Ruby Red BRILLANTE 3003 = RAL 3003		

TREND

 Pastel Blue OPACO 5224 = RAL 5024	 Pigeon Blue OPACO 5214 = RAL 5014	 Gentian Blue OPACO 5210 = RAL 5010
 Sapphire Blue OPACO 5203 = RAL 5003	 Blue Night OPACO 0289	

FINISHES

Esclusivamente per modelli Charleston, Toga, Ribbon e Subway

 Technoline BRILLANTE 0325	 Technoline OPACO 0328
---	---

STANDARD

 Traffic White BRILLANTE 9016 = RAL 9016
--

Alcune finiture sono disponibili solo per determinati prodotti. I codici RAL e NCS sono definiti dal produttore. I colori presenti in questa pagina sono solo per uso esplicativo e non possono essere considerati utili alla scelta della finitura, consigliamo per tale scopo l'utilizzo della cartella colori Zehnder.

Nonostante le cure apportate alla realizzazione di questa cartella colori ed i continui controlli di qualità effettuati sulla verniciatura dei nostri caloriferi, il prodotto finito può presentare lievi differenze rispetto alla cartella colori o ad altri materiali di riferimento (ceramica, carta, metallo ...). In funzione dei metodi di produzione adottati, i prodotti possono presentare lievi differenze rispetto alla tonalità del colore e/o alla sua brillantezza.

LEGENDA

	Nome del colore FINITURA N. Zehnder = codifica gamma
---	---